

## 20V N-CANNEL ENHANCEMENT MODE MOSFET

### SUMMARY

**$V_{(BR)DSS}=20V$ ;  $R_{DS(ON)}= 0.1\Omega$ ;  $I_D=3.2A$**

### DESCRIPTION

This new generation of high density MOSFETs from Zetex utilise a unique structure that combines the benefits of low on-resistance with fast switching speed. This makes them ideal for high efficiency, low voltage, power management applications.

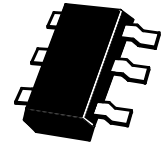

**SOT23-6**

### FEATURES

- Low on-resistance
- Fast switching speed
- Low threshold
- Low gate drive
- SOT23-6 package

### APPLICATIONS

- DC - DC Converters
- Power Management Functions
- Disconnect switches
- Motor control

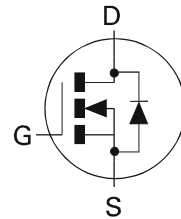

### ORDERING INFORMATION

DEVICE	REEL SIZE (inches)	TAPE WIDTH (mm)	QUANTITY PER REEL
ZXM62N02E6TA	7	8mm embossed	3000 units
ZXM62N02E6TC	13	8mm embossed	10000 units

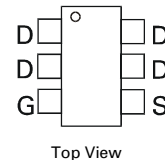

### DEVICE MARKING

- 2N02

# ZXM62N02E6

## ABSOLUTE MAXIMUM RATINGS.

PARAMETER	SYMBOL	LIMIT	UNIT
Drain-Source Voltage	$V_{DSS}$	20	V
Gate Source Voltage	$V_{GS}$	$\pm 12$	V
Continuous Drain Current ( $V_{GS}=4.5V$ ; $T_A=25^\circ C$ )(b) ( $V_{GS}=4.5V$ ; $T_A=70^\circ C$ )(b)	$I_D$	3.2 2.6	A
Pulsed Drain Current (c)	$I_{DM}$	18	A
Continuous Source Current (Body Diode) (b)	$I_S$	2.1	A
Pulsed Source Current (Body Diode)	$I_{SM}$	18	A
Power Dissipation at $T_A=25^\circ C$ (a) Linear Derating Factor	$P_D$	1.1 8.8	W mW/ $^\circ C$
Power Dissipation at $T_A=25^\circ C$ (b) Linear Derating Factor	$P_D$	1.7 13.6	W mW/ $^\circ C$

## THERMAL RESISTANCE

PARAMETER	SYMBOL	VALUE	UNIT
Junction to Ambient (a)	$R_{\theta JA}$	113	$^\circ C/W$
Junction to Ambient (b)	$R_{\theta JA}$	73	$^\circ C/W$

### NOTES

(a) For a device surface mounted on 25mm x 25mm FR4 PCB with high coverage of single sided 1oz copper, in still air conditions

(b) For a device surface mounted on FR4 PCB measured at  $t \leq 5$  secs.

(c) Repetitive rating - pulse width limited by maximum junction temperature. Refer to Transient Thermal Impedance graph.

CHARACTERISTICS

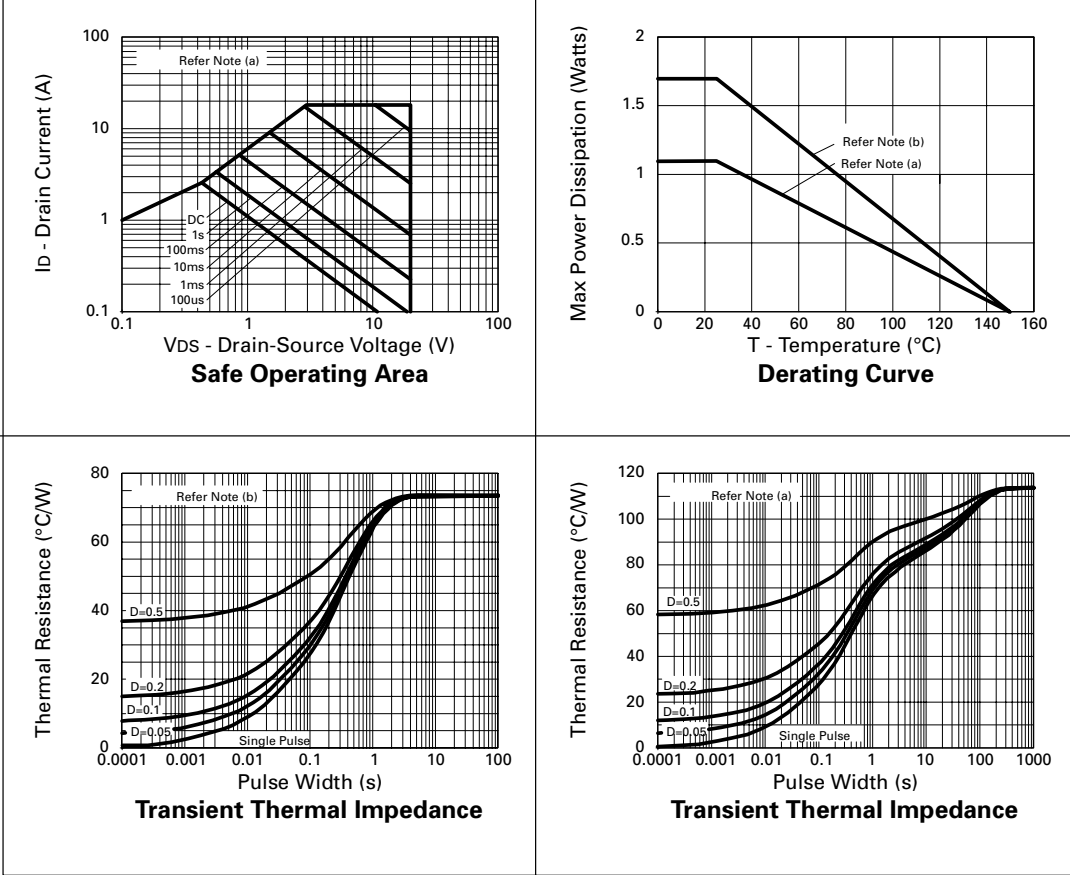

# ZXM62N02E6

## ELECTRICAL CHARACTERISTICS (at $T_{amb} = 25^{\circ}\text{C}$ unless otherwise stated).

PARAMETER	SYMBOL	MIN.	TYP.	MAX.	UNIT	CONDITIONS.
<b>STATIC</b>						
Drain-Source Breakdown Voltage	$V_{(BR)DSS}$	20			V	$I_D=250\mu\text{A}, V_{GS}=0\text{V}$
Zero Gate Voltage Drain Current	$I_{DSS}$			1	$\mu\text{A}$	$V_{DS}=20\text{V}, V_{GS}=0\text{V}$
Gate-Body Leakage	$I_{GSS}$			100	nA	$V_{GS}=\pm 12\text{V}, V_{DS}=0\text{V}$
Gate-Source Threshold Voltage	$V_{GS(th)}$	0.7			V	$I_D=250\mu\text{A}, V_{DS}=V_{GS}$
Static Drain-Source On-State Resistance (1)	$R_{DS(on)}$			0.1 0.125	$\Omega$	$V_{GS}=4.5\text{V}, I_D=2.2\text{A}$ $V_{GS}=2.7\text{V}, I_D=1.1\text{A}$
Forward Transconductance	$g_{fs}$	3.2			S	$V_{DS}=10\text{V}, I_D=1.1\text{A}$
<b>DYNAMIC (3)</b>						
Input Capacitance	$C_{iss}$		460		pF	$V_{DS}=15\text{V}, V_{GS}=0\text{V},$ $f=1\text{MHz}$
Output Capacitance	$C_{oss}$		150		pF	
Reverse Transfer Capacitance	$C_{rss}$		50		pF	
<b>SWITCHING(2) (3)</b>						
Turn-On Delay Time	$t_{d(on)}$		4.0		ns	$V_{DD}=10\text{V}, I_D=2.2\text{A}$ $R_G=6.0\Omega, R_D=4.4\Omega$ (refer to test circuit)
Rise Time	$t_r$		10.4		ns	
Turn-Off Delay Time	$t_{d(off)}$		16.9		ns	
Fall Time	$t_f$		8.0		ns	
Total Gate Charge	$Q_g$			6.3	nC	$V_{DS}=16\text{V}, V_{GS}=4.5\text{V},$ $I_D=2.2\text{A}$ (refer to test circuit)
Gate-Source Charge	$Q_{gs}$			1.5	nC	
Gate Drain Charge	$Q_{gd}$			2.5	nC	
<b>SOURCE-DRAIN DIODE</b>						
Diode Forward Voltage (1)	$V_{SD}$			0.95	V	$T_j=25^{\circ}\text{C}, I_S=2.2\text{A},$ $V_{GS}=0\text{V}$
Reverse Recovery Time (3)	$t_{rr}$		17.5		ns	$T_j=25^{\circ}\text{C}, I_F=2.2\text{A},$ $di/dt=100\text{A}/\mu\text{s}$
Reverse Recovery Charge (3)	$Q_{rr}$		8.6		nC	

(1) Measured under pulsed conditions. Width=300 $\mu\text{s}$ . Duty cycle  $\leq 2\%$  .

(2) Switching characteristics are independent of operating junction temperature.

(3) For design aid only, not subject to production testing.

TYPICAL CHARACTERISTICS

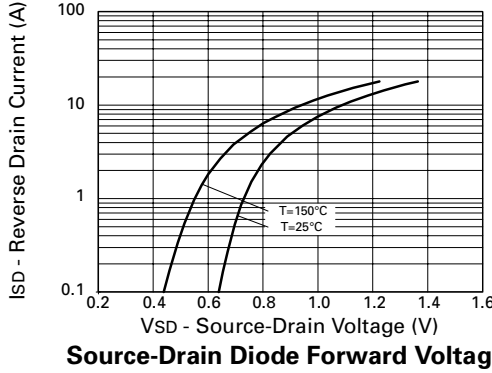
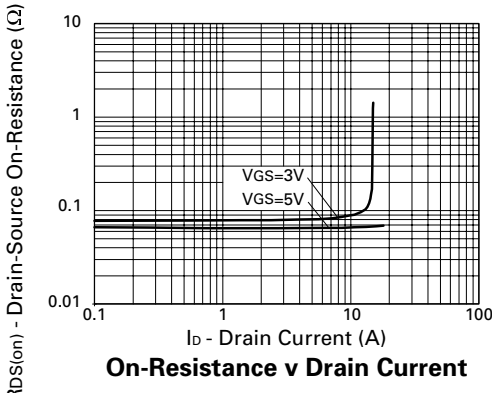
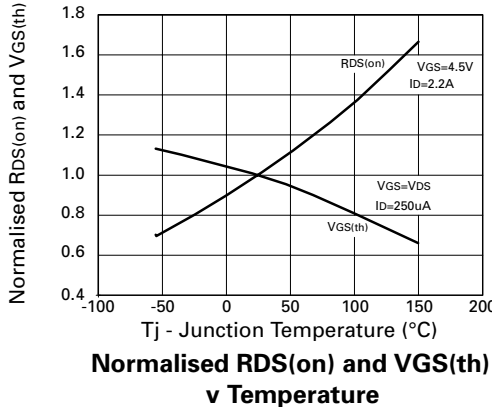
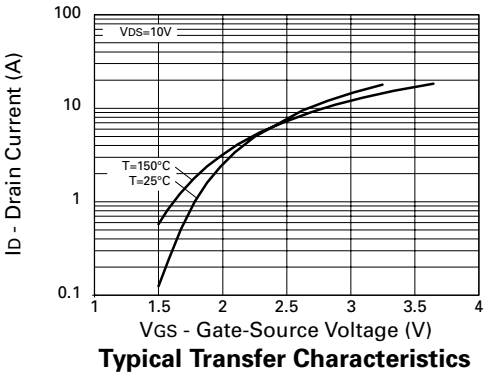
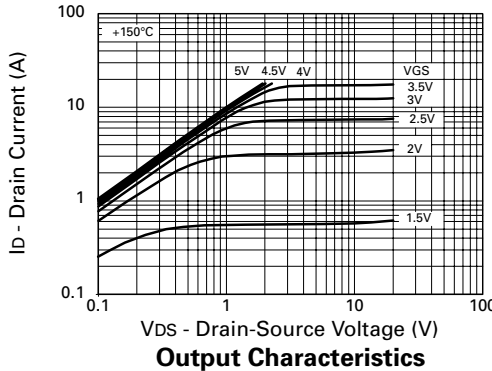
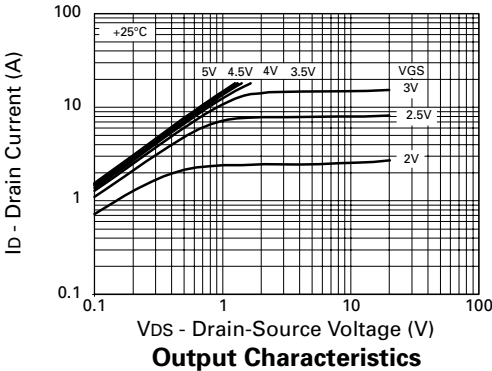

# ZXM62N02E6

## TYPICAL CHARACTERISTICS

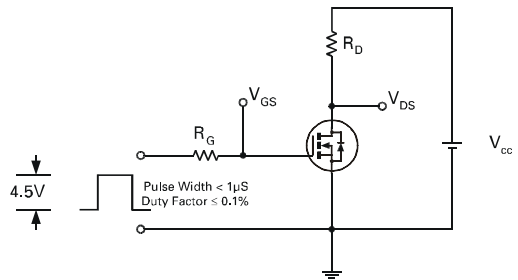
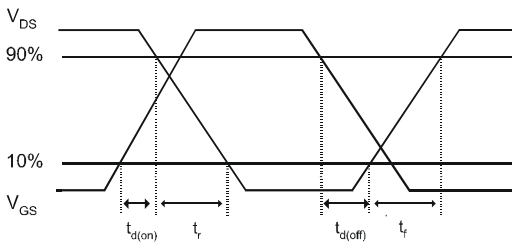
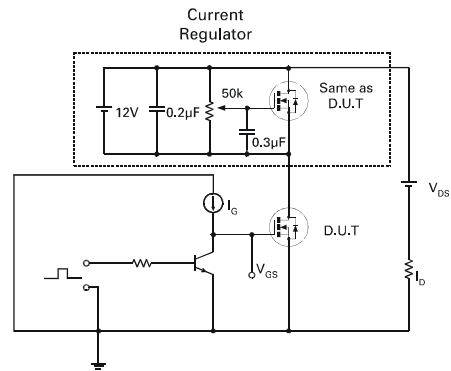
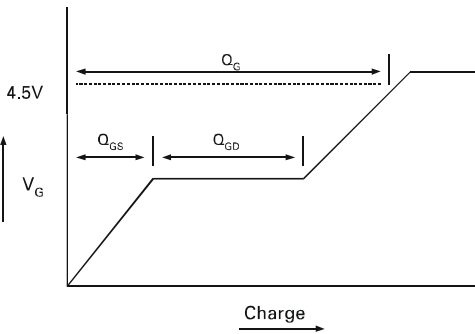
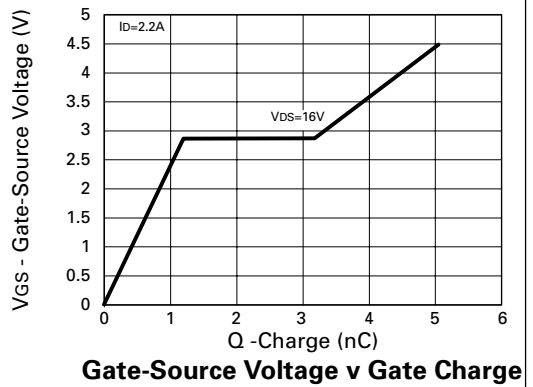
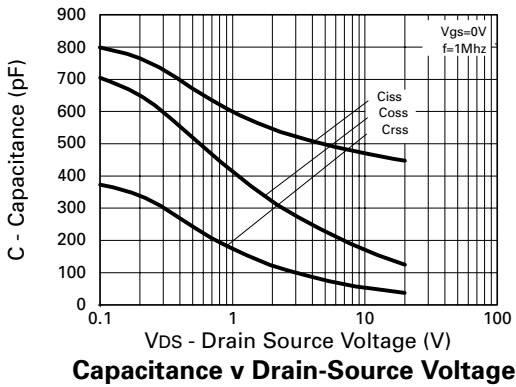

**ZXM62N02E6**

# ZXM62N02E6

## PACKAGE DIMENSIONS

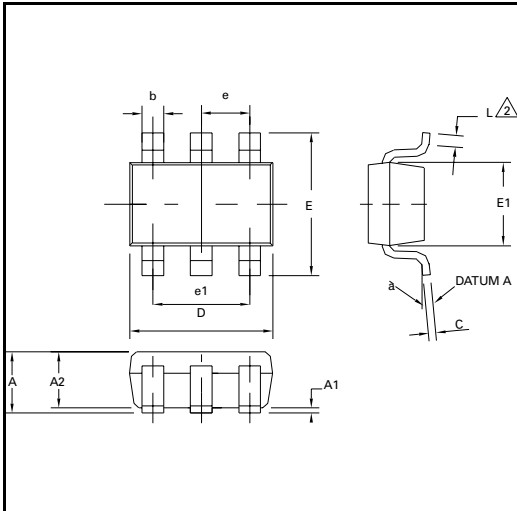

## PAD LAYOUT DETAILS

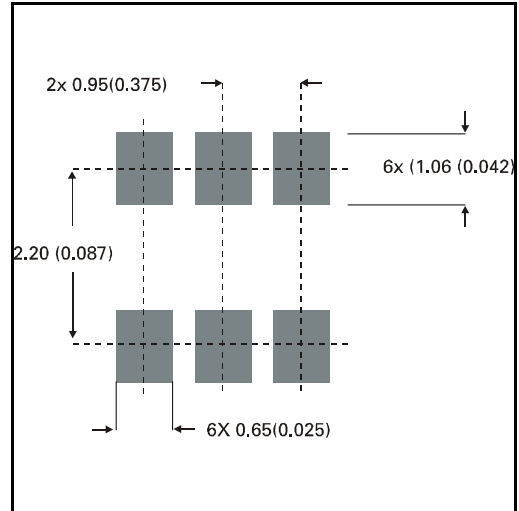

DIM	Millimetres		Inches	
	Min	Max	Min	Max
A	0.90	1.45	0.35	0.057
A1	0.00	0.15	0	0.006
A2	0.90	1.30	0.035	0.051
b	0.35	0.50	0.014	0.019
C	0.09	0.20	0.0035	0.008
D	2.80	3.00	0.110	0.118
E	2.60	3.00	0.102	0.118
E1	1.50	1.75	0.059	0.069
L	0.10	0.60	0.004	0.002

**ZETEX** Zetex plc.  
 Fields New Road, Chadderton, Oldham, OL9-8NP, United Kingdom.  
 Telephone: (44)161 622 4422 (Sales), (44)161 622 4444 (General Enquiries)  
 Fax: (44)161 622 4420

Zetex GmbH  
 Streifeldstraße 19  
 D-81673 München  
 Germany  
 Telefon: (49) 89 45 49 49 0  
 Fax: (49) 89 45 49 49 49

Zetex Inc.  
 47 Mall Drive, Unit 4  
 Commack NY 11725  
 USA  
 Telephone: (516) 543-7100  
 Fax: (516) 864-7630

Zetex (Asia) Ltd.  
 3510 Metroplaza, Tower 2  
 Hing Fong Road,  
 Kwai Fong, Hong Kong  
 Telephone: (852) 26100 611  
 Fax: (852) 24250 494

These are supported by  
 agents and distributors in  
 major countries world-wide  
 © Zetex plc 1999

Internet: <http://www.zetex.com>

This publication is issued to provide outline information only which (unless agreed by the Company in writing) may not be used, applied or reproduced for any purpose or form part of any order or contract or be regarded as a representation relating to the products or services concerned. The Company reserves the right to alter without notice the specification, design, price or conditions of supply of any product or service.